



CAR & ACCES SOR IES



BL



MA



GR



NE



09.PN060 PORTADOCUMENTI AUTO

- cucitura robusta
- chiusura con bottone
- dimensioni: cm 20x13,5 ca
- materiale: similpelle
- imballo: 50/100
- area di stampa: cm 15x1,5 (fascia)



BR

BS

BL

SI

NS

BY

09.PN062
PORTADOCUMENTI AUTO

- cucito
- chiusura con bottone
- dimensioni: cm 20x13,5 ca
- materiale: gommato
- imballo: 50/100
- area di stampa: cm 15x1,5 (fascia)



BL

SI

NE

09.PN082
PORTADOCUMENTI MOTO

- 2 ante
- 6 tasche interne
- copertina rigida imbottita
- dimensioni: cm 9x12,5 ca
- materiale: tam
- imballo: 100/100



09.PN090
PORTADOCUMENTI AUTO

- chiusura con pattina
- 4 schede estraibili
- dimensioni: cm 19,5x13 ca
- materiale: pvc
- imballo: 25/200
- area di stampa: cm 17x4



BL

NE



09.PN086
PORTADOCUMENTI AUTO

- 4 schede estraibili
- dimensioni: cm 19,5x15,5 ca
- materiale: tam
- imballo: 25/100
- area di stampa: cm 17x12



RO

09.PN100
PORTADOCUMENTI AUTO

- marcatura a secco in argento
- chiusura con pattina
- dimensioni: cm 20x13,5 ca
- materiale: tam
- imballo: 100
- area di stampa: cm 18x4



VE

BL

GI

GR

BO

BL

GI



RO

VE

BU



09.PN102 PORTADOCUMENTI AUTO

- marcatura neutra a secco
- chiusura con pattina
- dimensioni: cm 20x13,5 ca
- materiale: tam
- imballo: 100
- area di stampa: cm 18x4

RO

09.PN150

PORTAPOLIZZA UNIVERSALE

- dimensioni: cm 25x19 ca
- materiale: pvc
- imballo: 100/500



BI

BL

09.PN151

**PORTADOCUMENTI
AUTO - MOTO - FARMACIA**

- dimensioni: cm 18x13,5 ca
- materiale: pvc
- imballo: 100/1000



BL

BI

09.PN153

DISCO ORARIO MINI

- con rotella in cartone rigido
- forniti su fogli interi da 8 con traforatura per la separazione
- dimensioni: cm 7x12 ca
- materiale: pvc + adesivo
- imballo: 96/2.016
- area di stampa: cm 6x2 (retrovetro) cm 5,5x2 (fronte superiore) cm 5,5x2,5 (fronte inferiore)

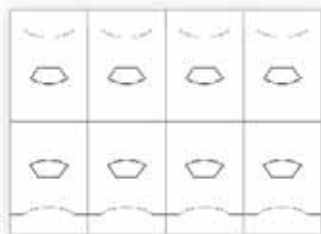

FOGLIO INTERO DA 8

BI



BL



09.PN154

DISCO ORARIO MAXI

- custodia trasparente
- dimensioni: cm 12x15 ca
- materiale: pvc
- imballo: 100/500
- area di stampa: cm 10x2,2

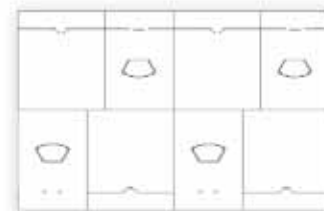

FOGLIO INTERO DA 4

BI



09.PN155

PORTA CONTRASSEGNO

- disco orario con rotella in cartone rigido
- forniti su fogli interi da 4 con traforatura per la separazione
- dimensioni: cm 16x12 ca
- materiale: pvc + adesivo • imballo: 1000
- area di stampa: cm 15x2 (retrovetro)
cm 8x7 (fronte)

BL

VE

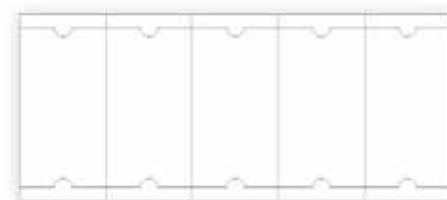

FOGLIO INTERO DA 10

BI



09.PN160

PORTA CONTRASSEGNO AUTO

- forniti su fogli interi da 10 con traforatura per la separazione
- dimensioni: cm 10x9,5 ca
- materiale: pvc + adesivo • imballo: 1000
- area di stampa: cm 8,5x1,5 (retrovetro)
cm 8x6 (fronte)

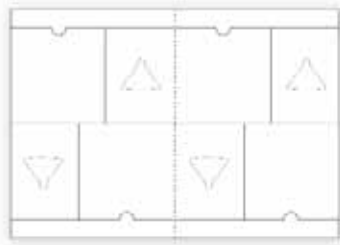

FOGLIO INTERO DA 4

BL



BI



09.PN161 PORTA CONTRASSEGNO

- disco orario con pomello in plastica
- forniti su fogli interi da 4 con traforatura per la separazione
- dimensioni: cm 16x12 ca
- materiale: pvc + adesivo
- imballo: 100/1000
- area di stampa: cm 15x2 (retrovetro) cm 8x7 (fronte)

BI



BL

FOGLIO INTERO DA 8

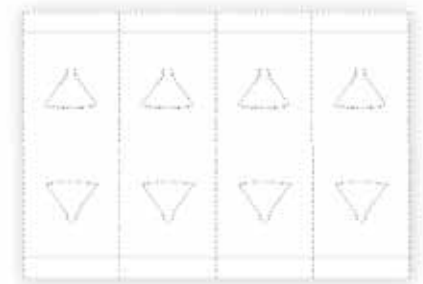

09.PN162 DISCO ORARIO MINI

- con pomello in plastica
- forniti su fogli interi da 8 con traforatura per la separazione
- dimensioni: cm 7x12 ca
- materiale: pvc + adesivo
- imballo: 96/2.016
- area di stampa: cm 6,5x2 (retrovetro) cm 6x2 (fronte)

09.PN201 PORTATARGA AUTO POSTERIORE

- dimensioni: cm 53,5x13,5 ca
- materiale: acciaio verniciato
- imballo: 100
- area di stampa: cm 50x1



NE

SI

Acciaio Verniciato

09.PN203 PORTATARGA AUTO ANTERIORE

- dimensioni: cm 37,5x13,5 ca
- materiale: acciaio verniciato
- imballo: 100
- area di stampa: cm 34,5x1,2



SI

NE

09.PN200 KIT FERMATARGA PER ART PN201

- composto da:
 - 2 graffette antivibrazione dim. mm 10xh8
 - 3 bottoni fermatarga blu dim. mm 9xh8
 - 1 bottone fermatarga bianco dim. mm 9xh8
- materiale: plastica resistente
- imballo: 100/1000



SI



Acciaio Verniciato

NE



Acciaio Plastificato

09.PN206
PORTATARGA SCOOTER

- dimensioni: cm 15x16 ca
- materiale: acciaio
- imballo: 100
- area di stampa: cm 13x2

SI



Acciaio Verniciato

NE



Acciaio Plastificato

09.PN207
PORTATARGA SCOOTER

- dimensioni: cm 19,5x23 ca
- materiale: acciaio
- imballo: 100
- area di stampa:
 cm 17x8,5 (massima)
 cm 17x1,2 (minima)

09.PN210
PORTATARGA AUTO
ANTERIORE

- dimensioni: cm 37,5x13,5 ca
- materiale: alluminio anti ossidazione
- imballo: 100
- area di stampa: cm 33x1,2



Alluminio
Anti Ossidazione

09.PN200
KIT FERMATARGA
PER ART PN212

- composto da:
- 2 graffette antivibrazione dim. mm 10xh8
- 3 bottoni fermatarga blu dim. mm 9xh8
- 1 bottone fermatarga bianco dim. mm 9xh8
- materiale: plastica
- imballo: 100/1000



09.PN208
PORTATARGA
MOTO

- dimensioni: cm 19,5x23 ca
- materiale: alluminio anti ossidazione
- imballo: 100
- area di stampa: cm 16x3



09.PN212
PORTATARGA AUTO
POSTERIORE

- dimensioni: cm 53,5x13,5 ca
- materiale: alluminio anti ossidazione
- imballo: 100
- area di stampa: cm 49x1



NE

Alta Resistenza



09.PN215 PORTATARGA AUTO POSTERIORE

- dimensioni: cm 52,5x13 ca
- materiale: plastica antiurto
- imballo: 100
- area di stampa: cm 45x1,2

NE

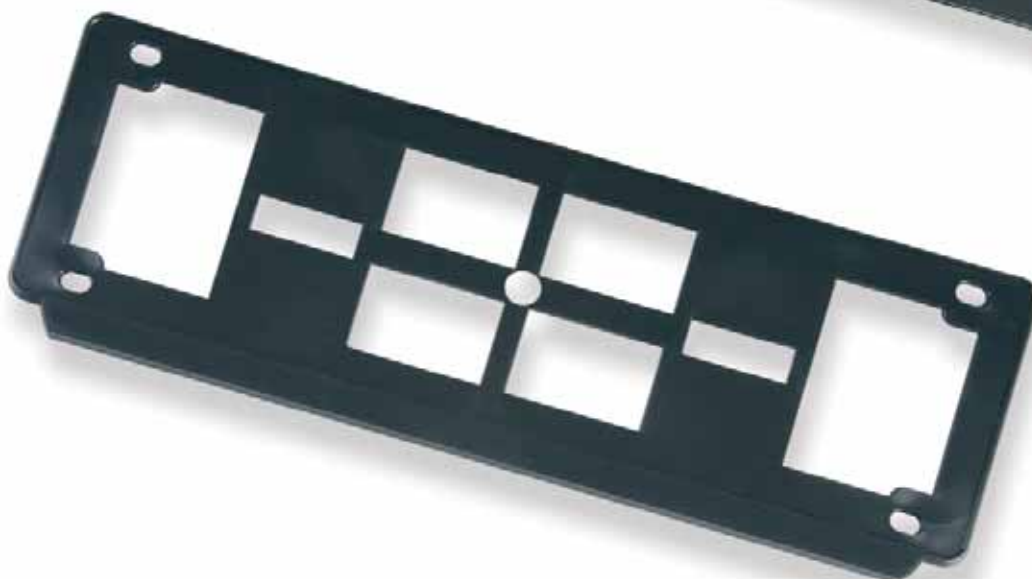

09.PN225 PORTATARGA AUTO ANTERIORE

- dimensioni: cm 36,5x13 ca
- materiale: plastica antiurto
- imballo: 100
- area di stampa: cm 31x1

SI

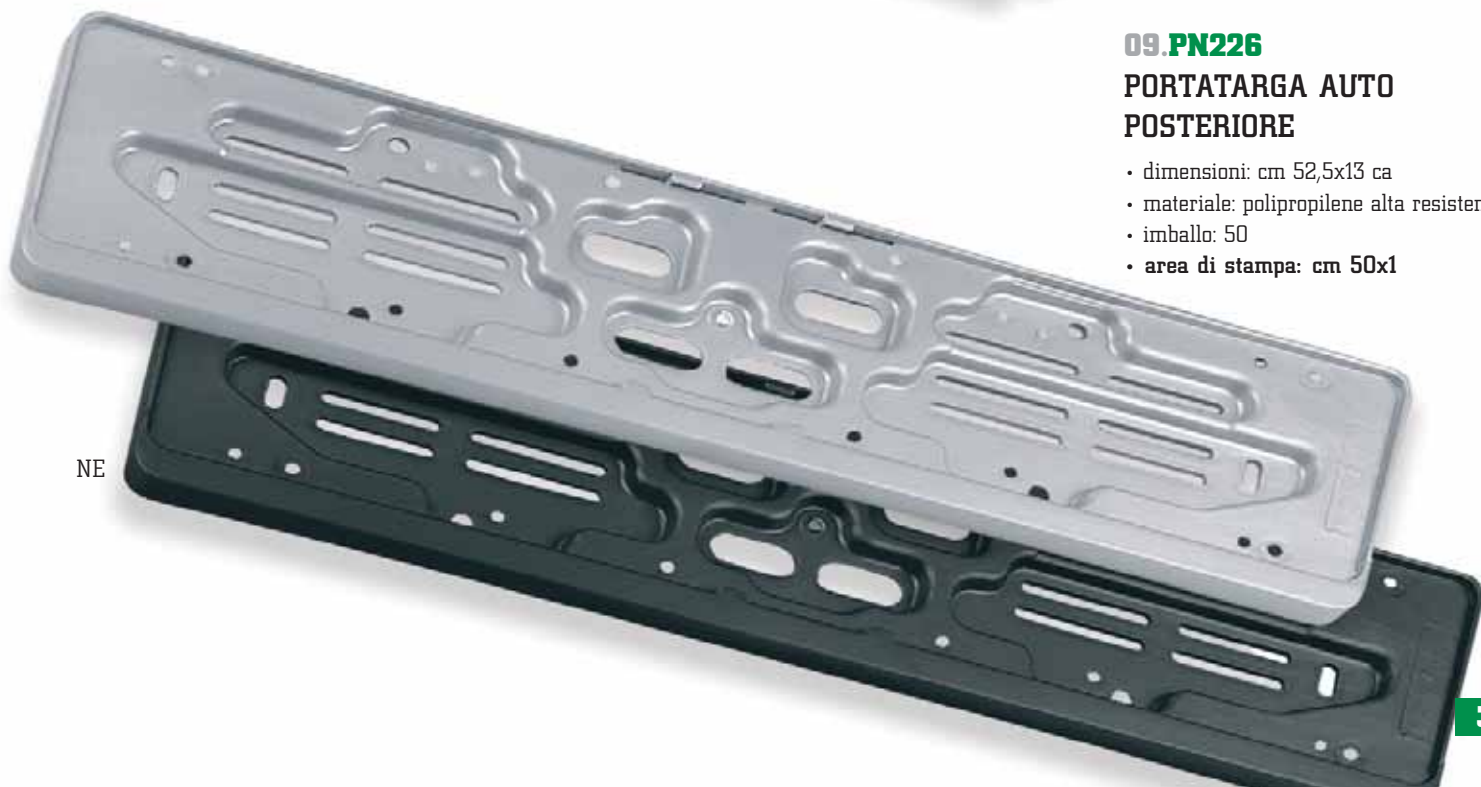

09.PN226 PORTATARGA AUTO POSTERIORE

- dimensioni: cm 52,5x13 ca
- materiale: polipropilene alta resistenza
- imballo: 50
- area di stampa: cm 50x1

NE

NE



09.PN227
PORTATARGA AUTO
ANTERIORE

- dimensioni: cm 36,5x13 ca
- materiale: polipropilene alta resistenza
- imballo: 100
- area di stampa: cm 31x1

SI



09.PN228
PORTATARGA SCOOTER

- dimensioni: cm 15x15 ca
- materiale: plastica antiurto
- imballo: 100
- area di stampa: cm 13x1,4



09.PN229
PORTATARGA MOTO

- dimensioni: cm 18,5x21 ca
- materiale: plastica antiurto
- imballo: 100
- area di stampa: cm 16x1,4



GI

09.PN259
PANNO TERGIVETRO

- dimensioni: cm 30x35 ca
- materiale: tnt
- imballo: 100/1000



Misura lo **Spessore**
del tuo **Battistrada**

09.PE860 TIRE LIGHTER

- accendino piezoelettrico ricaricabile
- include strumento per la misurazione dello spessore dei battistrada
- dimensioni: cm 2,4x8 ca • materiale: plastica solid e metallo
- imballo: 50/1000 • area di stampa: cm 1x5,5 (retro)



SI



NE RO VE BL AR GI



09.PN270
PORTAPATENTE
CARDS

- 3 ante
- dimensioni: cm 9,5x6,5 ca (chiuso)
- materiale: pvc
- imballo: 100/1000

Tutto in **Tasca**



09.PN272
PORTAPATENTE/CARDS

- 3 ante
- dimensioni: cm 9,5x6,5 ca (chiuso)
- materiale: tam
- imballo: 100/1000





09.PN273
PORTA CARDS

- 6 tasche
- dimensioni: cm 7,5x10,3 ca (chiuso)
- materiale: pvc
- imballo: 100/1000

FOGLIO INTERO DA 6



09.PN279
BUSTINA PORTA CARDS

- 1 tasca
- forniti su fogli interi da 6 con traforatura per la separazione
- dimensioni: cm 10x7 ca (chiuso)
- materiale: pvc
- imballo: 720/3.600



BI



BL

Retro



TR



FOGLIO INTERO DA 4

09.PN281

PORTA CARDS

- 2 tasche
- forniti su fogli interi da 4 con traforatura per la separazione
- dimensioni: cm 9,5x6,2 ca (chiuso)
- materiale: pvc
- imballo: 960/4.800



Comodo e **Tascabile**

TR



RO



BL

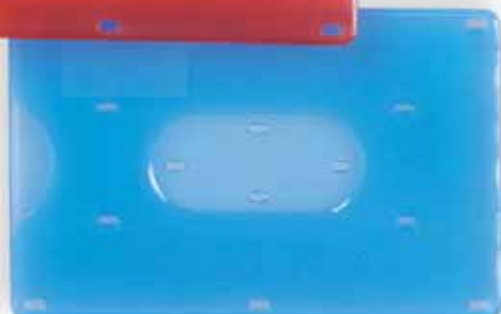

GI



09.PN284

PORTA CARDS RIGIDO

- dimensioni: cm 9x6 ca
- materiale: plastica trasparente
- imballo: 200/1000
- area di stampa: cm 5x0,8